

KENWOOD

COMPACT CD SYSTEM

MS-A5

INSTRUCTION MANUAL

KENWOOD CORPORATION



B60-1471-08 (K,T,E,M,X,Y) MC
94/12 11 10 9 8 7 6 5 4 3 2 1 93/12 11 10 9 8

Introduction

For your records

Record the serial number, found on the back of the unit, in the spaces designated on the warranty card, and in the space provided below. Refer to the model and serial numbers whenever you call upon your dealer for information or service on this product.

Model MS-A5 Serial Number _____

Unpacking

Unpack the unit carefully and make sure that all accessories are put aside so they will not be lost.

Examine the unit for any possibility of shipping damage. If your unit is damaged or fails to operate, notify your dealer immediately. If your unit was shipped to you directly, notify the shipping company without delay. Only the consignee (the person or company receiving the unit) can file a claim against the carrier for shipping damage.

We recommend that you retain the original carton and packing materials for use should you transport or ship the unit in the future.

When your unit needs to be repaired, bring the entire set (Speaker excluded) to your dealer.

The marking of products using lasers (Except for some areas.)



The label is attached to the back panel and says that the component uses laser beams that have been classified as Class 1. It means that the unit is utilizing laser beams that are of a weaker class. There is no danger of hazardous radiation outside the unit.

WARNING NOTICE:

IN MOST CASES IT IS AN INFRINGEMENT OF COPYRIGHT TO MAKE COPIES OF TAPES OR DISCS WITHOUT THE PERMISSION OF THE COPYRIGHT OWNERS. ANYONE WISHING TO COPY COMMERCIALY AVAILABLE TAPES OR DISCS SHOULD CONTACT THE MECHANICAL COPYRIGHT PROTECTION SOCIETY LIMITED OR THE PERFORMING RIGHTS SOCIETY LIMITED.

For the U.S.A.

Note to CATV system installer:

This reminder is provided to call the CATV system installer's attention to Article 820-40 of the NEC that provides guide-lines for proper grounding and, in particular, specifies that the cable ground shall be connected to the grounding system of the building, as close to the point of cable entry as practical.

Accessories

Remote control unit



AM loop antenna

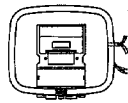

FM indoor antenna



Batteries



AC plug adaptor



Speaker cords



Only some areas

Contents

Caution: Read the pages marked Δ carefully to ensure safe operation.

Δ Before applying power	3	Listening to the radio	14
Δ Safety precautions	3	Playing CDs	16
Δ IMPORTANT SAFEGUARDS	4	Listening to tapes	20
Before operation	6	Recording operation	22
Antenna connections	8	Changing the tone	27
Connections	9	Operation of timer	28
Part names	10	Using the DISPLAY key	30
Operation of remote control unit	12	In case of difficulty	31
Setting the current time on the clock	13	Specifications	32

Before applying power

⚠ Caution: Read this page carefully to ensure safe operation.

For the U.S.A. and Canada

Important!

Units shipped to the U.S.A. and Canada are designed for operation on 120 volts AC only.

CAUTION: TO PREVENT ELECTRIC SHOCK DO NOT USE THE AC PLUG WITH AN EXTENSION CORD, RECEPTACLE OR OTHER OUTLET UNLESS THE BLADES CAN BE FULLY INSERTED TO PREVENT BLADE EXPOSURE.

For the United Kingdom

Important!

Units shipped to the U.K. are designed for operation on 240 volts AC only.

Factory fitted moulded mains plug

1. The mains plug contains a fuse. For replacement, use only a 13-Amp ASTA-approved (BS1362) fuse.
2. The fuse cover must be refitted when replacing the fuse in the moulded plug.
3. Do not cut off the mains plug from this equipment. If the plug fitted is not suitable for the power points in your home or the cable is too short to reach a power point, then obtain an appropriate safety approved extension lead or adapter, or consult your dealer.
If nonetheless the mains plug is cut off, remove the fuse and dispose of the plug immediately, to avoid a possible shock hazard by inadvertent connection to the mains supply.

For Australia

Important!

Units shipped to Australia are designed for operation on 240 V AC only.

For Europe

Important!

Units shipped to Europe are designed for operation on 230 V AC only.

For other countries

Important!

Units shipped to countries other than the above countries are equipped with an AC voltage selector switch on the **bottom cover**. Refer to the following paragraph for the proper setting of this switch.

AC voltage selection

This unit operates on 110 - 120 or 220 - 240 volts AC. The AC voltage selector switch on the **bottom cover** is set to the voltage that prevails in the area to which the unit is shipped. Before connecting the power cord to your AC outlet, make sure that the setting position of this switch matches your line voltage. If not, it must be set to your voltage in accordance with the following direction.

Note:

Our warranty does not cover damage caused by excessive line voltage due to improper setting of the AC voltage selector switch.





AC voltage selector switch



Move switch lever to match your line voltage with a small screwdriver or other pointed tool.

Safety precautions

WARNING: TO PREVENT FIRE OR ELECTRIC SHOCK, DO NOT EXPOSE THIS APPLIANCE TO RAIN OR MOISTURE.

 <div style="border: 1px solid black; padding: 2px; text-align: center;"> CAUTION <small>RISK OF ELECTRIC SHOCK DO NOT OPEN</small> </div> 	<p>CAUTION: TO REDUCE THE RISK OF ELECTRIC SHOCK, DO NOT REMOVE COVER (OR BACK). NO USER-SERVICEABLE PARTS INSIDE, REFER SERVICING TO QUALIFIED SERVICE PERSONNEL.</p>
	<p>THE LIGHTNING FLASH WITH ARROW-HEAD SYMBOL, WITHIN AN EQUILATERAL TRIANGLE, IS INTENDED TO ALERT THE USER TO THE PRESENCE OF UNINSULATED "DANGEROUS VOLTAGE" WITHIN THE PRODUCT'S ENCLOSURE THAT MAY BE OF SUFFICIENT MAGNITUDE TO CONSTITUTE A RISK OF ELECTRIC SHOCK TO PERSONS.</p>
	<p>THE EXCLAMATION POINT WITHIN AN EQUILATERAL TRIANGLE IS INTENDED TO ALERT THE USER TO THE PRESENCE OF IMPORTANT OPERATING AND MAINTENANCE (SERVICING) INSTRUCTIONS IN THE LITERATURE ACCOMPANYING THE APPLIANCE.</p>

IMPORTANT SAFEGUARDS Caution: Read this page carefully to ensure safe operation.

Please read all of the safety and operating instructions before operating this appliance. Adhere to all warnings on the appliance and in the instruction manual. Follow all the safety and operating instructions. These safety and operating instructions should be retained for future reference.

- 1. Power sources** – The appliance should be connected to a power supply only of the type described in the instruction manual or as marked on the appliance. If you are not sure of the type of power supply to your home, consult your appliance dealer or local power company. For appliances intended to operate from battery power, or other sources, refer to the instruction manual.
- 2. Power-cord protection** – Power-supply cords should be routed so that they are not likely to be walked on or pinched by items placed upon or against them, pay particular attention to cords at plugs, convenience receptacles, and the point where they exit from the appliance.

Never pull or stretch the cord.



- 3. CAUTION – Polarization** – This appliance may be equipped with a polarized alternating-current line plug (a plug having one blade wider than the other). This plug will fit into the power outlet only one way. This is a safety feature. If you are unable to insert the plug fully into the outlet, try reversing the plug. If the plug should still fail to fit, contact your electrician to replace your obsolete outlet. Do not defeat the safety purpose of the polarized plug.
- 4. Ventilation** – Slots and openings in the cabinet are provided for ventilation and to ensure reliable operation of the appliance and to protect it from overheating, and these openings must not be blocked or covered. The appliance should be situated so that its location or position does not interfere with its proper ventilation. To maintain good ventilation, do not put records or a tablecloth on the appliance. Place the appliance at least 10 cm away from the walls. Do not use the appliance on a bed, sofa, rug or similar surface that may block the ventilation openings. This appliance should not be placed in a built-in installation such as a bookcase or rack unless proper ventilation is provided or the manufacturer's instructions have been adhered to.

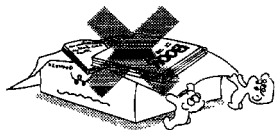

- 5. Water and moisture** – The appliance should not be used near water - for example, near a bathtub, washbowl, kitchen sink, laundry tub, in a wet basement, or near a swimming pool, etc.

- 6. Temperature** – The appliance may not function properly if used at extremely low, or freezing temperatures. The ideal ambient temperature is above +5°C (41°F).
- 7. Heat** – The appliance should be situated away from heat sources such as radiators, heat registers, stoves, or other appliances (including amplifiers) that produce heat.
- 8. Electric shock** – Care should be taken so that objects do not fall and liquid is not spilled into the enclosure through openings. If a metal object, such as a hair pin or a needle, comes into contact with the inside of this appliance, a dangerous electric shock may result. For families with children, never permit children to put anything, especially metal, inside this appliance.

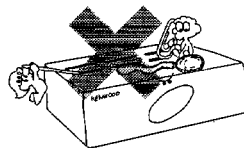

- 9. Enclosure removal** – Never remove the enclosure. If the internal parts are touched accidentally, a serious electric shock might occur.

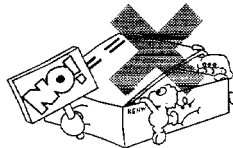

- 10. Magnetic fields** – Keep the appliance away from sources of magnetic fields such as TV sets, speaker systems, radios, motorized toys or magnetized objects.
- 11. Cleaning** – Unplug this appliance from the wall outlet before cleaning. Do not use volatile solvents such as alcohol, paint thinner, gasoline, or benzene, etc. to clean the cabinet. Use a clean dry cloth.
- 12. Accessories** – Do not place this appliance on an unstable cart, stand, tripod, bracket, or table. The appliance may fall, causing serious injury to a child or adult, and serious damage to the appliance. Use only with a cart, stand, tripod, bracket, or table recommended by the manufacturer, or sold with the appliance. Any mounting of the appliance should follow the manufacturer's instructions, and should use a mounting accessory recommended by the manufacturer. An appliance and cart combination should be moved with care. Quick stops, excessive force, and uneven surfaces may cause the appliance and cart combination to overturn.



IMPORTANT SAFEGUARDS

Caution: Read this page carefully to ensure safe operation.

13. Lightning – For added protection for this appliance during a lightning storm, or when it is left unattended and unused for long periods of time, unplug it from the wall outlet and disconnect the antenna or cable system. This will prevent damage to the appliance due to lightning and power-line surges.

14. Abnormal smell – If an abnormal smell or smoke is detected, immediately turn the power OFF and unplug the appliance from the wall outlet. Contact your dealer or nearest service center.

POWER OFF!

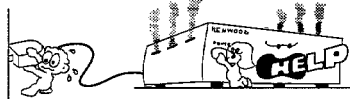

15. Damage requiring service – The appliance should be serviced by qualified service personnel when:

- A. The power-supply cord or the plug has been damaged.
- B. Objects have fallen, or liquid has been spilled into the appliance.
- C. The appliance has been exposed to rain or water.
- D. The appliance does not appear to operate normally by following the instruction manual. Adjust only those controls that are covered by the instruction manual as an improper adjustment of other controls may result in damage and will often require extensive work by a qualified technician to restore the appliance to its normal operation.
- E. The appliance has been dropped, or the enclosure damaged.
- F. The appliance exhibits a marked change in performance.

16. Servicing – The user should not attempt to service the appliance beyond that described in the instruction manual. All other servicing should be referred to qualified service personnel.

17. Outdoor antenna grounding – If an outside antenna is connected to the appliance, be sure the antenna system is grounded so as to provide some protection against voltage surges and built up static charges. Article 810 of the National Electrical Code – ANSI/NFPA 70, provides information with respect to proper grounding of the mast and supporting structure, grounding of the lead-in wire to an antenna discharge unit, size of grounding conductors, location of antenna discharge unit, connection to grounding electrodes, and requirements for the grounding electrode. See Figure.

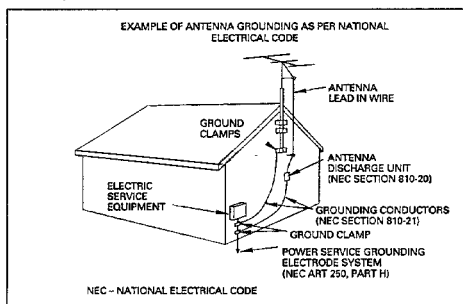

18. Power lines – An outside antenna system should not be located in the vicinity of overhead power lines or other electric light or power circuits, or where it can fall into such power lines or circuits. When installing an outside antenna system, extreme care should be taken to keep from touching such power lines or circuits as contact with them might be fatal.

19. Overloading – Do not overload wall outlets, extension cords, or integral convenience receptacles as this can result in a risk of fire or electric shock.

20. Attachment – Do not use attachments not recommended by the appliance manufacturer as they may cause hazards.

21. Replacement parts – When replacement parts are required, be sure the service technician has used replacement parts specified by the manufacturer or have the same characteristics as the original parts. Unauthorized substitutions may result in fire, electric shock, or other hazards.

22. Safety check – Upon completion of any service or repairs to this appliance, ask the service technician to perform safety checks to determine that the appliance is in proper operating condition.

For the U.S.A.

CAUTION:

Use of controls or adjustments or performance of procedures other than those specified herein may result in hazardous radiation exposure.

In compliance with Federal Regulations, following are reproductions of labels on, or inside the product relating to laser product safety.

KENWOOD CORPORATION
SHIONOGI SHIBUYA BUILDING 17-5,
2-CHOME, SHIBUYA, SHIBUYA-KU,
TOKYO, JAPAN

KENWOOD CORP. CERTIFIES THIS EQUIPMENT
CONFORMS TO D.H.S. REGULATIONS NO. 21 CFR 1040.10,
CHAPTER I, SUBCHAPTER J.

Location: Back Panel

Notes:

1. Item 3 is not required except for grounded or polarized equipment.
2. Item 17 and 18 are not required except for units provided with antenna terminals.
3. Item 17 complies with UL in the U.S.A.

Before operation

Notes on cassette tape

- **Safety tab (accidental erasure prevention tab):**
After an important recording has been finished, break the safety tab, to prevent the recorded contents from being erased or recorded on accidentally.

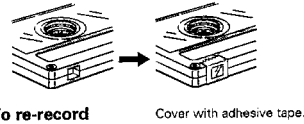
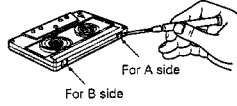

- **To store cassette tapes:**
Do not store the tapes in a place which is subject to direct sunlight, or near equipment that generates heat. Keep the cassette tapes away from any magnetic field.

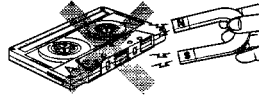

- **When there is slack in the tape:**
In such a case, insert a pencil into the reel hole and wind the reel hub to remove the slack.

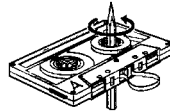

Notes:

1. 120-minute cassette tape:
Since a 120-minute cassette tape is very thin, the tape could adhere to the pinch roller or be easily cut. It is recommended that these tapes not be used with this unit to prevent possible damage.
2. Endless tapes:
Do not use an endless tape, as this could damage the mechanism of the unit.

Cleaning the head section

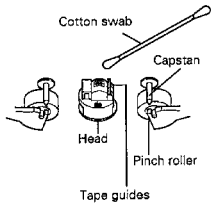

Cleaning the heads and peripheral components:

For maintaining the best condition of the deck and for longer service life, always keep the head (recording/playback/erase), capstan and pinch roller clean.

To clean them, perform the following:

1. Open the cassette holder.
2. Using a cotton swab dipped in alcohol, clean the head (recording/playback/erase), capstan and pinch roller carefully.

Demagnetizing the head

When the recording/playback head is magnetized, the sound quality will be deteriorated. In such a case, demagnetize the head using a commercially available demagnetizer (head eraser).

Note:

There are precisely aligned parts around the heads, including the tape guides. When cleaning, pay special attention so as not to apply shock to them.

Disc handling precautions

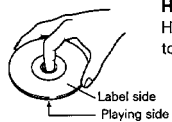

Handling

Hold compact discs so that you do not touch the playing surface.



Do not attach paper or tape to either the playing side or the label side of compact discs.



Cleaning

If fingerprints or foreign matter become attached to the disc, lightly wipe the disc with a soft cotton cloth (or similar) from the center of the disc outwards in a radial manner.

Storage

When a disc is not to be played for a long period of time, remove it from the CD player and store it in its case.

Before operation

■ Beware of condensation

When water vapor comes into contact with the surface of cold material, water drops are produced. If condensation occurs, correct operation may not be possible, or the unit may not function correctly. This is not a malfunction, however, and the unit should be dried. (To do this, turn the POWER switch ON and leave the unit as it is for several hours.)

Be especially careful in the following conditions:

- When the unit is brought from a cold place to a warm place, and there is a large temperature difference.
- When a heater starts operating.
- When the unit is brought from an air-conditioned place to a place of high temperature with high humidity.
- When there is a large difference between the internal temperature of the unit and the ambient temperature, or in conditions where condensation occurs easily.

■ Setting the channel space (only some areas)

The space between broadcast stations is called the channel space. This space will differ depending on the country. You can set the proper channel space for the country in which you will be using the unit, immediately after you insert the plug of the power cord into the power outlet. When you insert the power plug into the outlet:

Area	AM CHANNEL SPACE
U.S.A. and Canada	10 kHz
Other countries	9 kHz

- Operate with the POWER key being kept OFF.

① Either "STEP 9 kHz" or "STEP 10 kHz" will be displayed.

② If "STEP 9 kHz" is displayed and you wish to change to 10 kHz: →

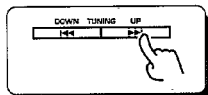

③ If "STEP 10 kHz" is displayed and you wish to change to 9 kHz: →

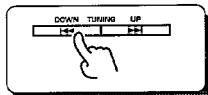

④ Press the TUNER key to confirm the setting.

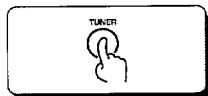

- Now, the setting operation is completed.
- The power is applied and either AM 531 kHz (for STEP 9 kHz) or AM 530 kHz (for STEP 10 kHz) is displayed.

- If the AM channel spaces are changed, the characteristics for FM band are also changed so that they match with those in the corresponding area.

Dolby noise reduction system

The Dolby noise reduction system was developed to reduce the tape hiss noise generated during playback. The optimum effect of the Dolby NR system is obtained when the same type NR system is used for both recording and playback. If a different type NR system is used, playback is not performed correctly. Make sure that the same type noise reduction system is used for both recording and playback.

Dolby B NR

The most popular noise reduction system used in home audio components. Usually, Dolby NR system corresponds to B NR.

Dolby noise reduction manufactured under license from Dolby Laboratories Licensing Corporation. "DOLBY" and the double-D symbol  are trademarks of Dolby Laboratories Licensing Corporation.

Antenna connections

8

- ① Push the lever.
- ② Insert the cord.
- ③ Release the lever or Return the lever.

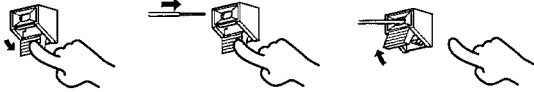

■ AM loop antenna connection

How to assemble

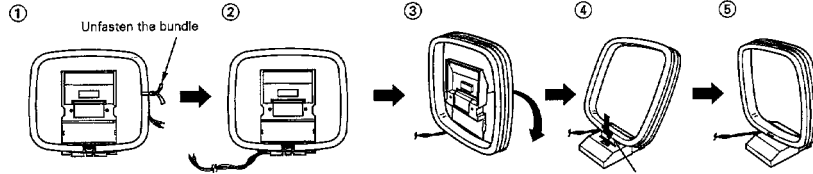

The supplied antenna is for indoor use. Place it as far as possible from the main system, TV set, speaker cords and power cord, and set it to a direction which provides the best reception.

If the reception is poor when the AM loop antenna is used, distribute a vinyl-coated wire of more than 6 meters outdoors, without disconnecting the loop antenna.

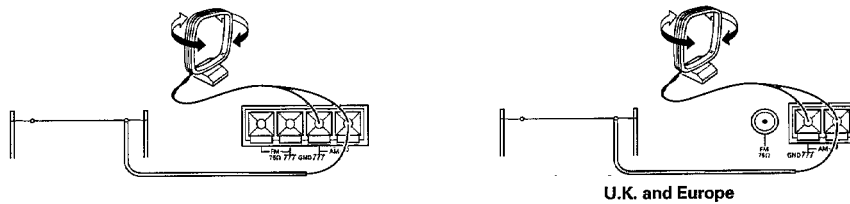

■ FM indoor antenna connection

The supplied antenna is for indoor use. For stable reception, remove the indoor antenna after installing an outdoor antenna as soon as possible.

- ① Find the position that provides best reception.
- ② Fix the end.



■ FM outdoor antenna connection

It is recommended to install an exclusive FM outdoor antenna to capture FM broadcasts with high sound quality. Use a coaxial cable for the connection between the outdoor antenna and FM ANTENNA terminal on the rear panel. For the connection between the coaxial cable and FM ANTENNA terminal, please refer to page 9.

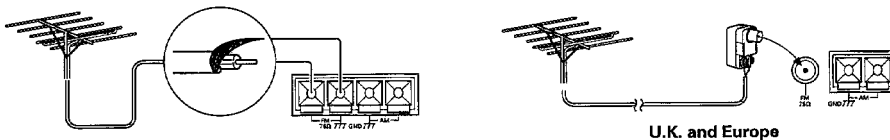

Connections

■ Connection of front speakers

① Push the lever.



② Insert the conductor.

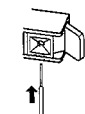

③ Return the lever.



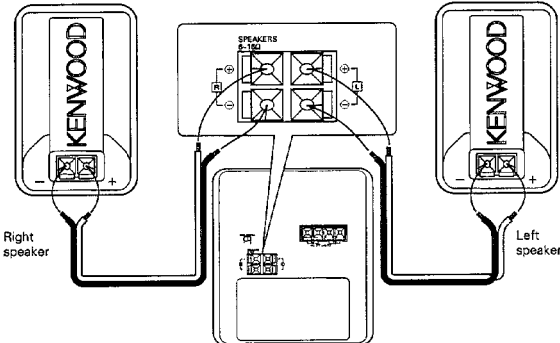

Right speaker

Left speaker

- Never short-circuit the + and - speaker cords.
- If the speaker cords are connected with reversed polarity, the sound becomes unnatural with ambiguous acoustic image positioning. Be sure to connect the speaker cords correctly.



Left speaker

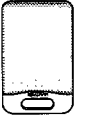

Right speaker

• The right and the left speakers are the same.

■ 75 Ω coaxial cable connection (For U.K. and Europe)

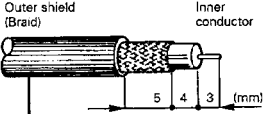
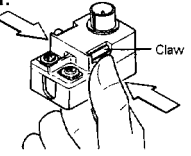
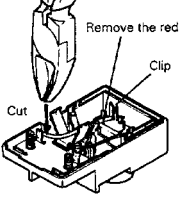
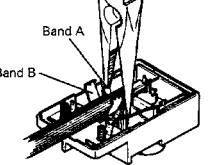
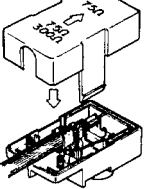
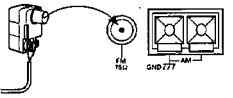
<p>① Arrange the coaxial cable as illustrated.</p>  <p>Outer shield (Braid)</p> <p>Inner conductor</p> <p>5 4 3 (mm)</p> <p>RG-6 (5C-2V) or RG-59 (3C-2V)</p>	<p>② Open the antenna adaptor. Press the claws in the direction of the arrows to release the lock and pull out the cover.</p>  <p>Claw</p>	<p>③ Cut off the red wire and remove it from the clip.</p>  <p>Remove the red wire</p> <p>Clip</p> <p>Cut</p>
<p>④ Insert into the slit on the clip. Fasten the bands A and B, using a pair of pliers.</p>  <p>Band A</p> <p>Band B</p>	<p>⑤ Close the cover.</p> 	<p>⑥ Connect the adaptor to the antenna terminal.</p>  <p>FM 75Ω</p> <p>GND/77</p>

Note:

To connect the 300 Ω feeder, attach the ring shown in the figure. If the ring is not attached, the sensitivity decreases.

Part names

Cassette deck / Amplifier section

The power will go on when keys marked with an asterisk (*) are pressed, even if it was off before the key was pressed.

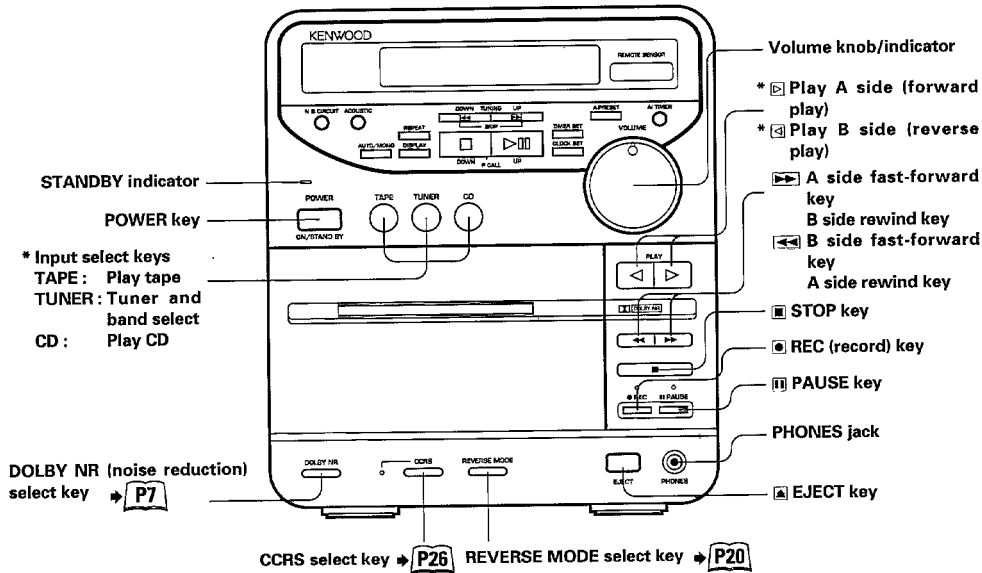

Tuner / CD player section

▶, ◀ TUNING / UP, DOWN
 When set to TUNER: channel select key
 When set to CD: SKIP key

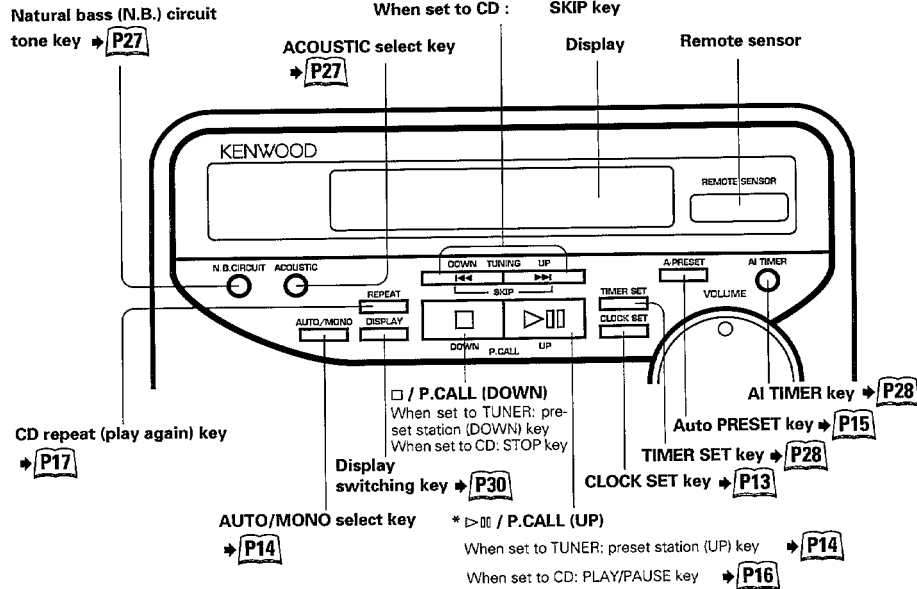

Part names

Display section

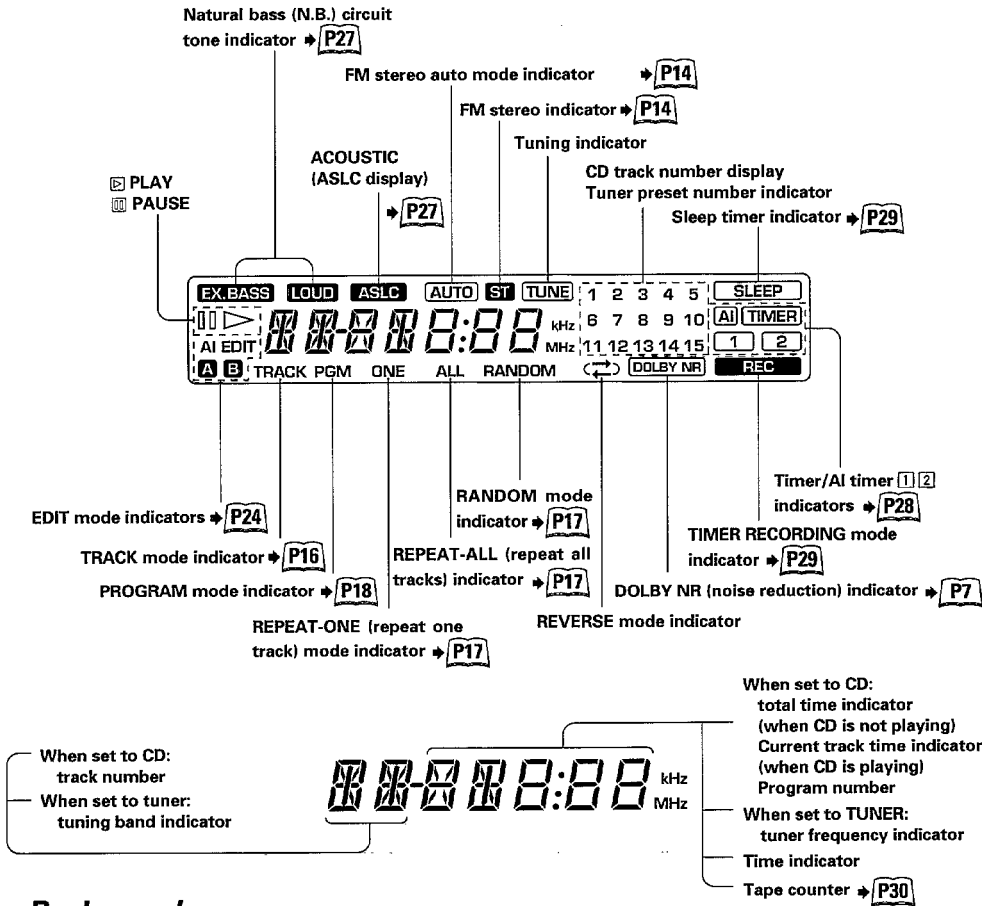

Back panel

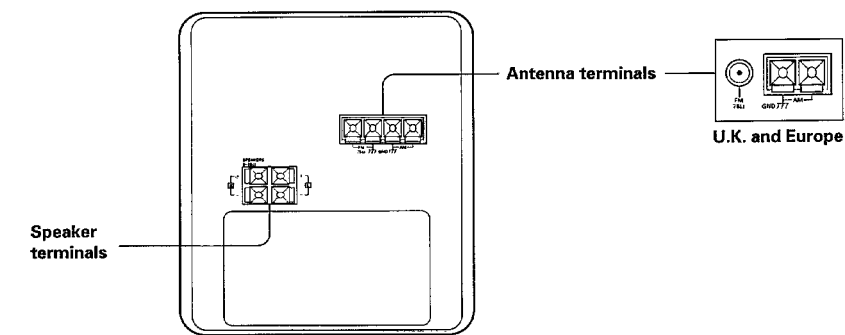

Operation of remote control unit

12

Loading batteries

1 Remove the cover.

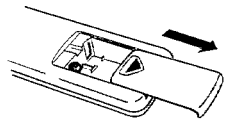

Slide the cover pressing the area.

2 Insert batteries.

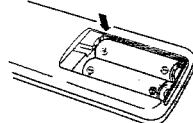

Insert two AA-size (R6) batteries as indicated by the polarity marking.

3 Close the cover.

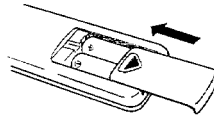

Operation procedure

Plug the power cord of the system into an AC wall outlet, and press the **POWER** key to turn the power on. The remote control unit is effective only in the range shown in the figure right.

- When two operation keys on the remote control unit are pressed successively, press each key securely reserving an interval of more than 1 second for each press.

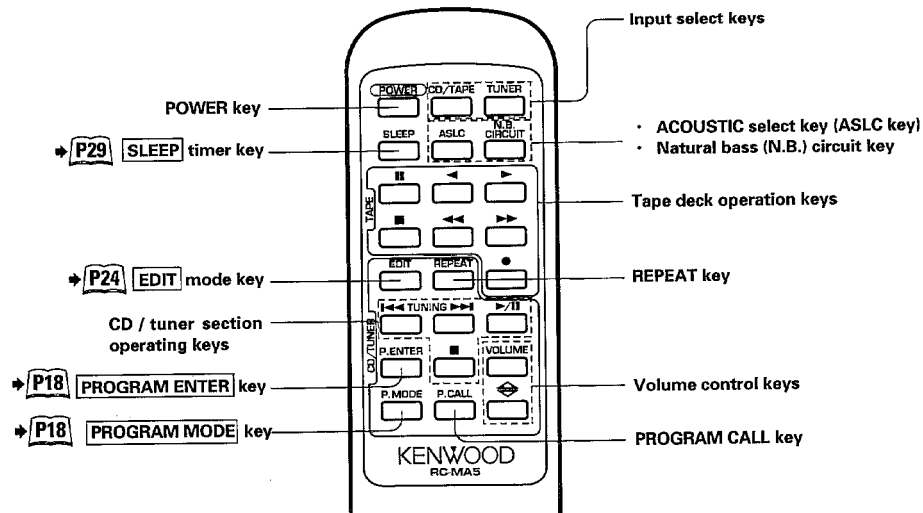
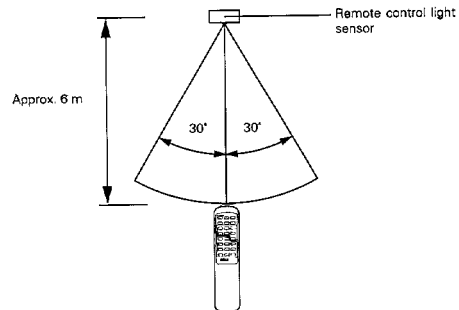

Names in boxes refer to keys only available on the remote control unit.

Notes:

- The supplied batteries are intended for use in operation checks. Therefore, their lives may be shorter than ordinary batteries.
- When the remote-controllable distance gets shorter than before, replace both batteries with new ones.
- Malfunction may occur if direct sunlight or the light of a fluorescent lamp using an inverter enters the remote control light sensor. In such a case, change the system installation position to prevent the malfunction.

Setting the current time on the clock

- This unit has a built-in clock. As soon as you start using the unit, you should set the current time on the clock in order to ensure that the timer functions work properly.
- In the event of a power failure, or when the plug has been removed from the power outlet, the clock display will blink to indicate that the time should be reset.

Note: the timer cannot be used unless the time has been set.

First of all, press the POWER key to turn on the power.

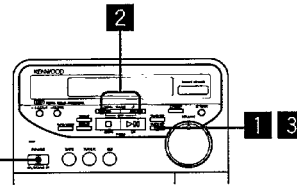

1 Press the CLOCK SET key.

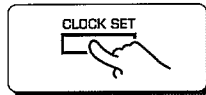

2 Use the << and >> keys to set the time.

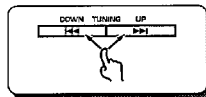

- To increase the minute setting, press the UP key once. The minute setting will increase 1 minute each time the key is pressed. Holding the key down will cause the minute and hour settings to increase quickly.
- To decrease the minute setting, press the DOWN key once. The setting will decrease 1 minute each time the key is pressed. Holding the key down will cause the minute and hour settings to decrease quickly.

3 Press the CLOCK SET key again.

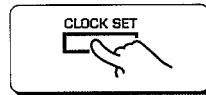

- When the current time has been set, press the "CLOCK SET" key again.

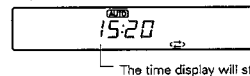

Adjusting the Volume

VOLUME

VOLUME

Remote control unit

- When the volume is changed using the remote control unit, the indicator lamp on the dial will flash on and off as the volume dial rotates.

Listening with Headphones

Insert the miniplug on the headphones into the PHONES jack on the unit. Use headphones equipped with a stereo miniplug, or use a stereo miniplug adaptor.

- The sound from the speakers will be cut off.
- Use the VOLUME dial to adjust the volume.

ONE-TOUCH OPERATION System

This unit is designed so the power will automatically go on and operation will begin when the TAPE, TUNER, CD, [▶▶], [◀◀], [⏮], [⏭] key on the unit, or the CD/TAPE key on the remote control unit is pressed.

Listening to the radio

FM stereo indicator

- When an FM stereo broadcast is received, the unit automatically switches to stereo mode and the **[ST]** display appears.

Preparations



Press TUNER. The power will go on and the unit will change to tuner input.

- If the signal is weak or there is a lot of static, you can improve reception by pressing the **[AUTO/MONO]** key to change the unit to MONO (monaural) mode.

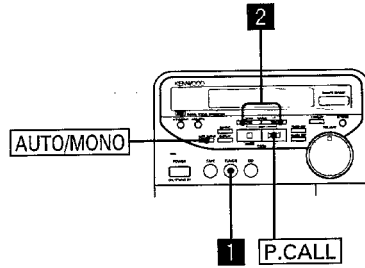

Tuning in radio broadcasts

1 Select the broadcast band.



- Press the TUNER key to switch between AM and FM bands.
- The unit will toggle between these two bands each time the key is pressed.

2 Select the station.

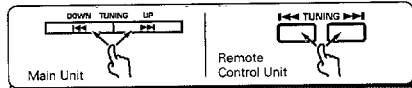

Hold down the UP or DOWN key for 1 second or more.

- The unit will scan up or down the dial (depending which button was pressed) and will stop when it finds a station.
- To continue searching, press the key again.
- When the unit appears to be having difficulty locating a station, press the **[TUNING]** UP or DOWN key lightly (without holding the key down). Each time the key is pressed, the frequency will change one step. Keep pressing the key until the desired frequency is reached.

Tuning in a Preset Station

Follow the instructions on page 15 to preset the desired stations in memory.

1 Select the desired preset station.



Each time the **[P.CALL]** UP key on the unit or the **[P.CALL]** key on the remote control unit is pressed, the unit will cycle to the next preset station.

The number of the current station will appear on the display.

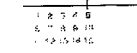
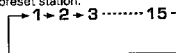

Display

- By pressing the **[P.CALL]** DOWN key on the unit stations can be selected in reverse order (15 → 14 → 13 and so on).

Auto preset (main unit only)

1 Select the broadcast band.

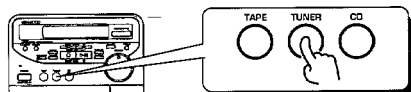

- The band will toggle between AM and FM each time the TUNER key is pressed.

2 Press the A.PRESET (automatic preset) key.

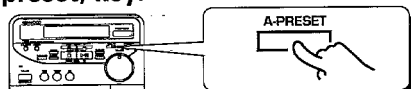

- The unit will search the selected band and automatically store up to 15 stations into memory, after which it will stop automatically.

In some cases the unit will also mistake frequencies with powerful static for broadcast stations and store these as well. If this happens, use the preset procedure shown below to change them to actual broadcast stations.

Changing preset stations using the auto preset key (main unit only)

1 Call up the number for the station you wish to change.

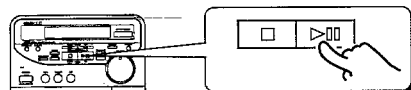

- Press the P.CALL UP key until the preset station that you wish to change is tuned in.

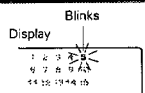

2 Select the desired broadcast band.



- If the broadcast band is changed, the preset number will disappear, but it is still retained in the unit's memory

3 Press the A.PRESET (automatic preset) key.

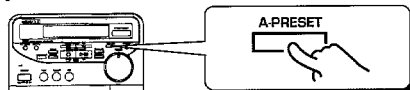

- Starting with the number you have selected in 1, the unit will search the selected band and assign stations up to number 15.

Example

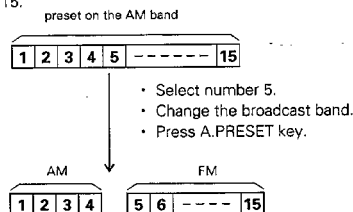

Manual preset (using remote control unit only)

1 Select the broadcast band.

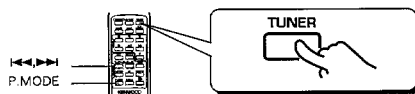

2 Tune in the station to be preset.



3 Press the P.MODE key (on the remote control unit).



4 Press the P.CALL key to select the desired preset number.

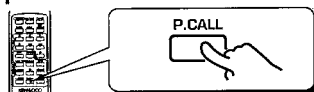

- Press the key until the desired number is displayed.

5 Press the P.MODE key to set the current station to that preset number.



6 Repeat the process.

- Repeat steps 1 through 5 until all 15 preset stations are set as desired.

Playing CDs

Preparations

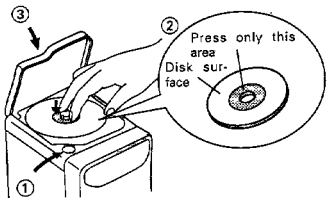

① Lift the lid of the CD compartment.



② Place the CD on the turntable. Press only the area near the hole, position the CD so it snaps into place.

③ Close the lid. If the CD mode is specified, the total number of tracks and total time of that CD will automatically appear in the display.

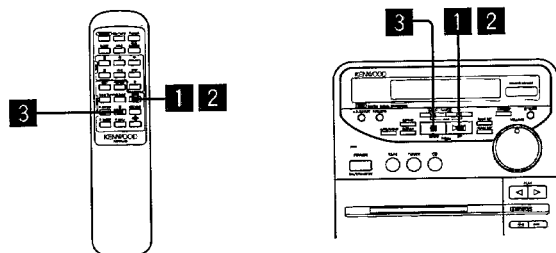
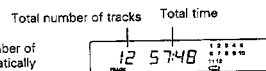
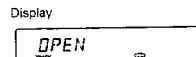

Playing tracks in sequence (TRACK mode)

1 Start playing the CD.

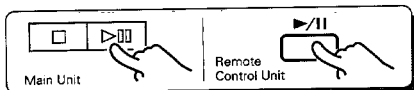

Even when the unit is set to TUNER, the CD begins playing by pressing the CD key among the Input select keys. When using the remote control unit, simply press the "▶/II" key and the CD will begin playing.

The power will come on and "CD" will appear in the display, and then the CD will begin playing.

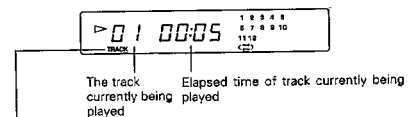

TRACK mode: used when no tracks have been programmed (in other words, when all tracks on the CD are being played in order from the beginning).

2 To pause CD play.

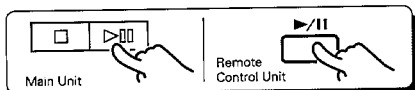

To cancel the pause status, press the "▶/II" (or ▶/II) key again.

3 To stop CD play.



When CD play is stopped, the display reverts to the total number of tracks and total time.

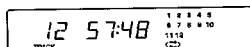

Playing CDs (Playing selected CD tracks)

Preparations

→ P16

- ① Lift the lid of the CD compartment.
- ② Insert the CD.
- ③ Close the lid.

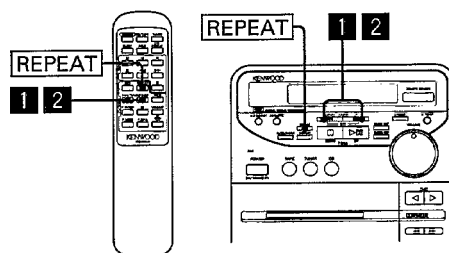

Select the desired tracks

- 1 To start listening to the tracks in order starting with a certain track (skipping tracks).

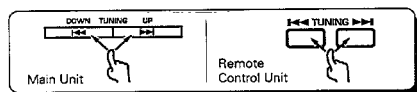

- Each time the "▶▶" key is pressed, the unit will move to the beginning of the next track.
- When the "◀◀" key is pressed, the unit will move to the beginning of the current track. Each time the key is pressed again after that, the unit will move to the beginning of the previous track.

- 2 To listen to previous or subsequent tracks (searching for tracks).

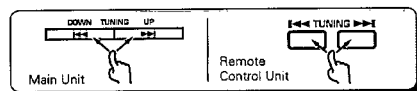

Hold down the ▶▶ or ◀◀ key.

- When the "▶▶" key is held down while playing a CD, the unit will move forward through subsequent tracks.
- When the "◀◀" key is held down while playing a CD, the unit will move backward through previous tracks.

Using the REPEAT key

The REPEAT key allows you to play a desired track again or play the tracks in random order.

- Repeat/Random play.

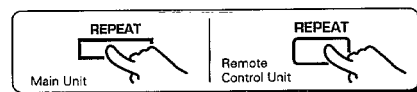

Each time the REPEAT key is pressed, the unit cycles through the following modes:

- ONE Plays the current track again.
- ALL Plays all tracks on the CD again. In program mode, plays only the programmed tracks in the programmed order.
- RANDOM Plays all tracks on the CD in random order.
 - If the random mode is selected, the program mode is canceled.
- OFF Returns to normal play mode.

Playing CDs (Programmed CD play)

18

When playing CDs, you can program any desired tracks to play in any desired order. This mode is called program mode. To do this, you must be in programmed play mode.

Preparations

→ P16

- ① Lift the lid of the CD compartment.
- ② Insert the CD.
- ③ Close the lid.
- ④ If the CD is currently playing, press the "■" key to stop it.

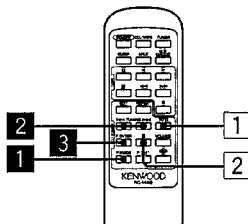

Programming Tracks (Remote Control Unit Only)

- 1 Press the P.MODE key to enter program mode.

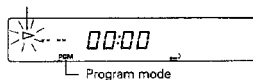
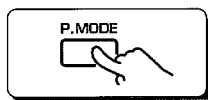

- 2 Select a track.

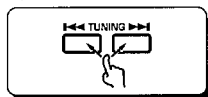

- The number will change each time one of the keys is pressed.

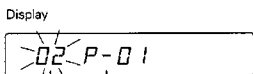

- 3 Press the P.ENTR key to record that track.

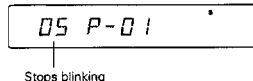

- If the P.ENTR key is pressed and held down for more than 2 seconds, the total playing time of the programmed track will be displayed.

- 4 Select the next track.

- Repeat steps 2 and 3 to program any other desired tracks. You may program up to 20 tracks.
- If you attempt to program any more tracks, the word FULL will appear on the display.

Playing the programmed tracks

- 1 To play the programmed tracks.

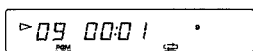

- The tracks will be played in the programmed order.
- If the "▶▶" or "◀◀" key is pressed while the programmed tracks are being played, the unit will move to the next programmed track in that direction.

- 2 To stop programmed play.



CAUTION: Pressing the "■" key again while the CD is stopped will erase the current program.

Playing CDs (Programmed CD play)

You can check, change or add to the program at will.

Preparations

- Press the "■" key to stop the CD from playing.
- CAUTION: if the CD is already stopped in program mode, pressing the "■" key again will erase the current program.

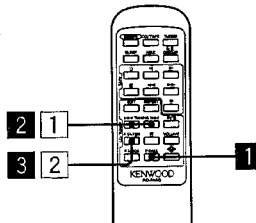

Checking or changing the program (remote control unit only)

- 1 To check the tracks that are currently programmed, press P.CALL to call up the program.

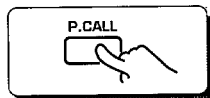

- The programmed track numbers will be displayed in sequence each time the key is pressed.

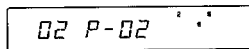

- 2 To program a different track, use the "◀◀" and "▶▶" keys to enter the desired track.

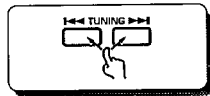

- With the program number to be changed shown on the display, use the "◀◀" or "▶▶" key to select the desired track.

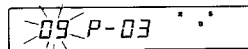

Begins blinking

- 3 Press the P.ENTER key to enter that track.

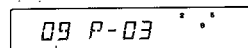
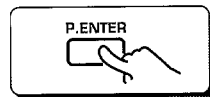

Stops blinking

Programming additional tracks (remote control unit only)

- 1 Enter the track to be added.

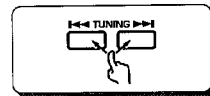

- When the "◀◀" and "▶▶" keys are used to select an additional track, that track will be added to the end of the current program.

- 2 Press the P.ENTER key to enter that track.

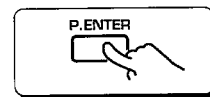

To erase the current program

To erase the current program, use any of the following methods:

- ① While the program is stopped, press the "■" key again.
- ② Press the "▲" key and open the lid of the CD compartment.
- ③ Press the P.MODE key.

Listening to tapes

Preparations

1 Insert the cassette tape.

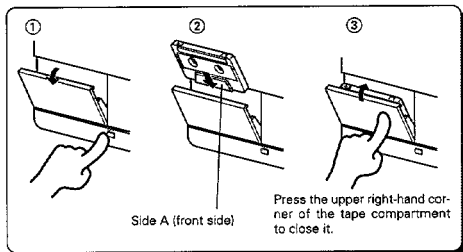

- Insert the tape as shown at left. ① ② ③
 - For the purposes of this manual, we will call the side facing you (the front side) "side A" and the other side (the back side) "side B." Playing or recording side A will be called "forward" play/recording; playing or recording side B will be called "reverse" play/recording.
 - There is no need to set the type of tape being used (normal, chrome or metal), as this will be automatically detected by the unit. (Metal tapes may only be played.)
 - Make sure the tape is tight before you insert it, as shown in the figure below.
- 

2 Select REVERSE mode or DOLBY NR, if desired.

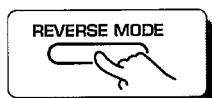

- ...One side of the tape will be played once.
- ...Both sides of the tape will be played once. If playing is started from the B side, it stops after only the B side is played up to its end.
- ...Both sides of the tape will be played over and over again.

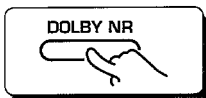

Toggles between these modes each time the key is pressed.

- Sets the unit to play tapes recorded in DOLBY NR (noise reduction) mode (see Page 7).

Playing tapes

To start playing the tape (PLAY).

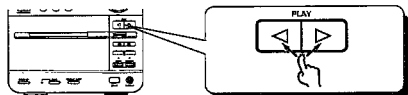

- When the "▷" key is pressed, side A will be played.
- When the "◁" key is pressed, side B will be played.

To stop the tape (STOP).

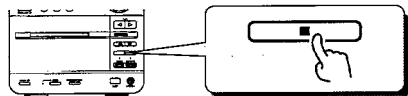

- Do not press the EJECT key when the tape is running.

To fast-forward or rewind the tape.

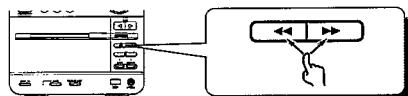

- "▶▶" key: used to fast-forward side A/rewind side B
- "◀◀" key: used to fast-forward side B/rewind side A

Playing direction

- Even when the power is turned off, it remembers the last tape playing direction. However, if the power cord is disconnected, the direction is automatically reset to ▷.
- To change the tape playing direction, insert the tape and press the desired PLAY key and then use the "■" key to stop the tape.

When a tape is inserted, the indicator lamp on one of the PLAY keys will light to indicate the playing direction.

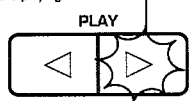

Side B (back side) Side A (front side)

Listening to tapes (DPSS)

DPSS stands for Direct Program Search System. Using the DPSS function on this unit, you can skip tracks on a tape or listen to the same track over and over.

• Skipping tunes

When you select a tune several tunes after (or before) the tune that is currently playing, the unit immediately skips to the beginning of the selected tune. You may select up to 16 tunes in this manner.

• Playing the same tune over

Select the same tune as many times as you wish to hear it (up to a maximum of 16 times).

• Dash and play

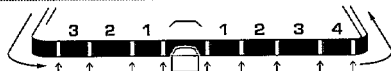
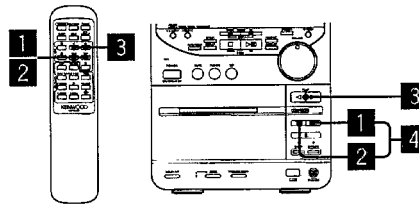

Space between tunes (unrecorded section) Space between tunes (unrecorded section)
Playing direction

Skipping tunes (DPSS)

1 Listening to a later tune (while another tune is playing).



When the A side of the tape is being played (the ▷ direction)

- For example, to play the 4th tune after the current tune, press 4 times.
- When the B side of the tape is being played (the ◁ direction), press the "◀◀" key.

2 Listening to an earlier tune (while another tune is playing).



When the A side of the tape is being played (the ▷ direction)

- To listen to the current tune from the beginning, press the "◀◀" key once.
- To listen to the 4th tune before the previous one, press the "◀◀" key 5 times.
- When the B side of the tape is being played (the ◁ direction), press the "▶▶" key.

3 Listening to the same tune over and over again (while that tune is playing).

- Press the key of the currently running direction once.



When the A side of the tape is being played (the ▷ direction)

- After the same tune has been played 16 times, the mode will revert to normal play mode.
- Skipping operation is not available while playing the same track over.
- To cancel the repeat play in mid-operation, press the "■" key on the deck, or press the "▷" key (or the "◁" key if the B side of the tape is being played).

4 Dash-and-play (main unit only)

- Press the "◀◀" and "▶▶" keys simultaneously, either while the tape is playing or when it is stopped.

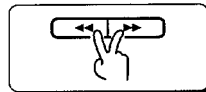

- When there is more than 10 seconds between tunes, the unit will fast-forward to the beginning of the next tune.
- The unit will not fast-forward in the case of the first tune on the flip side.
- Skipping operation is not available during dash-and-play.

Notes:

The skip and repeat operations may not work for the following types of tapes:

- Tapes of conversations, comedy or the like in which there are pauses of 4 seconds or longer
- Tapes of classical music or other types of music which contain very soft sections or silences
- Tapes with loud static or applause between tunes

Recording operation

- It is not possible to record to metal tapes on this unit (metal tapes may only be played).

Preparations



- ① Insert a cassette tape.
- ② Select reverse mode (either to record both sides once or to record one side only).
- ③ Select Dolby NR if desired.
- ④ Select the direction of tape movement: A (forward) or B (reverse).

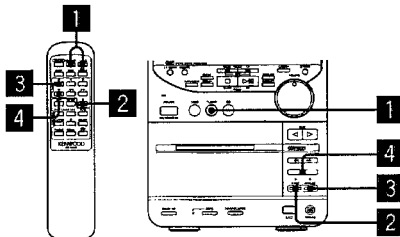

Normal recording

1 Select the source for recording.



- "TAPE" cannot be selected.
- When "CD" has been selected, press either the "□" key or "▷◁" key in the CD section to stop (or pause) the CD if it is playing.

2 Start recording.

- ① Start the source for recording.
- ② Press the REC key.



3 To pause recording.



or

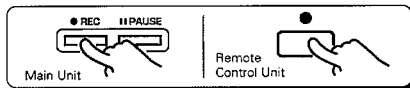

- When the REC key is pressed during recording, the deck enters the record-pause mode after creating a non-recorded blank of 4 seconds.
- To restart recording, press the REC key again.

4 To stop recording.

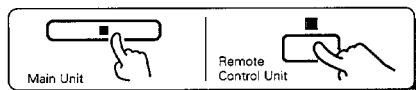

Beat cancel

When recording AM radio broadcasts, a high-pitched sound may be recorded. This is caused by the interaction of the recording circuit and the signal. This sound can be minimized by changing the circuit as follows:

- ① Tune in the AM broadcast and then set to recording pause mode.
- ② Press the tuning UP and DOWN keys simultaneously. The circuit will be changed each time the keys are pressed in this manner.

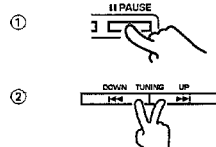

Recording operation (CD synchronized recording)

CD synchronized recording

When recording a CD, it is possible to start or pause recording using only the CD keys, without having to press the keys in the tape section.

Preparations

- ① Insert a cassette tape.
- ② Select reverse mode (either to record both sides once or to record one side only).
- ③ Select DOLBY NR if desired.
- ④ Select the direction of tape movement: A (forward) or B (reverse).
- ⑤ Insert the CD to be recorded.

→ P20

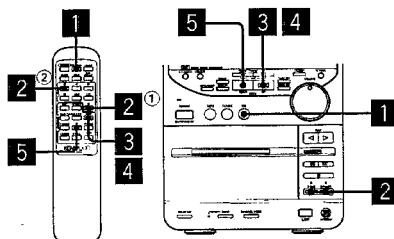

CD synchronized recording

1 Set the input to CD.

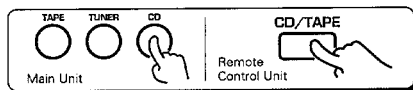

- After setting the input to CD, stop (or pause) the CD from playing by pressing the "□" key (or the ">|||" key) in the CD section.

2 Press the RECORD and PAUSE keys simultaneously.

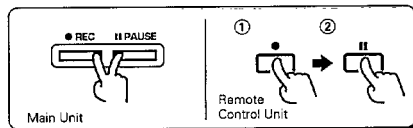

- Press the REC and PAUSE keys on the tape deck simultaneously.
- When performing this operation on the remote control unit, press the "●" key and then immediately afterward press the "||" key.

3 Start playing the CD.



- The unit will start recording as soon as the CD begins playing.
- When the CD has ended, recording will also stop.

4 To pause recording.

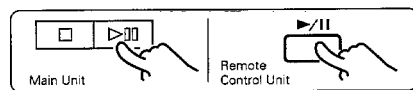

- The CD will pause and the tape will record silence for around 4 seconds and then pause as well.
- To start recording again, press the ">|||" key again on the CD player.

5 To stop recording.

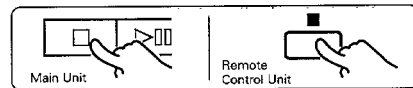

Press the stop key on the CD player.

- The tape will record around 4 seconds of silence and then stop.
- When the "■" key on the cassette deck has been pressed to stop recording, the CD will continue playing.

Recording of CD playback (Edit function)

The edit function is used for editing tunes from a CD for recording them onto a cassette tape. Three types of editing are available with this unit, as described below.

1. Normal edit

When the recording time of the tape is entered, the unit automatically assigns tunes from the CD for recording them on sides A and B of the tape. For the end of side A, the tune which best fits into the remaining time on that side is automatically selected.

- Editing is carried out for all tracks up to track number 22.

If there is no tune available which can fit in the specified tape recording length, "NO FILE" is displayed and the edit function is canceled.

2. Program edit

By programming tunes in advance and selecting normal edit mode, editing is carried out using the programmed tunes.

- If a track with a track number of 23 or greater is programmed, that track will not be included in the editing process.

3. AI edit

This mode automatically makes sure that all tunes from a CD are recorded onto the tape. If the CD recording time is longer than the tape, the unit automatically fades out the ends of each tune so that all tunes can be recorded.

- If the tape is extremely short, all tunes from the CD may not be recorded.

CD (track mode)

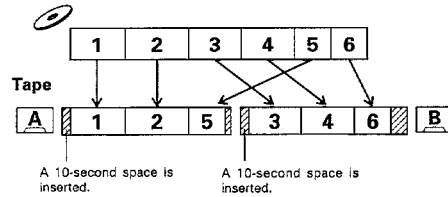

CD (program mode)

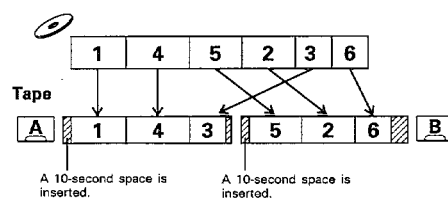

CD

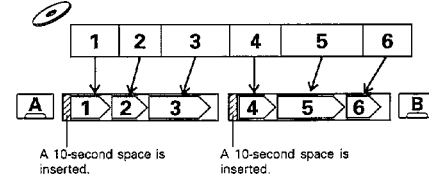

Fade-out

Fade-out refers to a gradual decrease of sound level from the normal to minimum at the end of music.

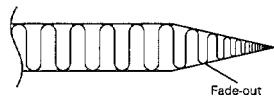

EDIT key

In the CD mode, the display changes one by one as shown below every time the EDIT key on the remote control unit is pressed:

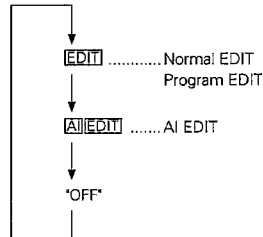

Recording operation (Edit function)

Preparations

→ P20

- ① Insert a cassette tape.
- ② Select reverse mode (either to record both sides once or to record one side only).
- ③ Select DOLBY NR if desired.
- ④ Select the direction of tape movement: A (forward) or B (reverse).
- ⑤ Insert the CD to be recorded.

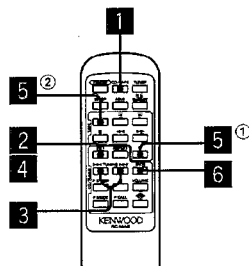

Edited Recording (Remote Control Unit Only)

1 Change the input to CD.

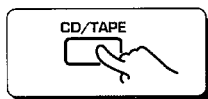

- After changing the input to CD, stop CD play by pressing the "■" key on the CD unit.
- To edit the program for recording, enter the desired program.

→ P18

2 Press the EDIT key to select edit mode.

→ P24

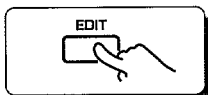

- Edit mode will change each time the "EDIT" key is pressed.
- If the next step is not performed within 8 seconds, edit mode will be canceled. If this happens, press the "EDIT" key again.

3 Set the tape length (total recording time for both sides).

Example:
In the case of a 45 minute tape,
set the tape length to "45"

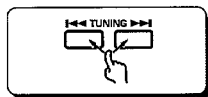

- Press the UP key once to increase the setting 1 minute. Beyond 9 minutes, the setting will return to 0 minutes.
- Press the DOWN key once to increase the setting 10 minutes. Beyond 90 minutes, the setting will return to 00 minutes. (The setting changes in 10-minute increments.)

4 Start the EDIT process.

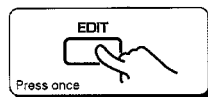

Press once

- Editing will begin automatically. When editing has been performed for both A and B sides, the [EDIT] display will stop blinking.

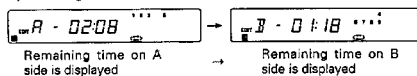

After several seconds

5 Pause recording.

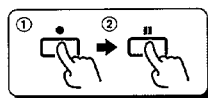

- Press the "●REC" key (Recording key) in the tape section and then immediately press the "II" key

6 Start playing the CD.



- Recording on the deck will begin and the CD will begin playing.
- When recording on the A side has been completed, the CD will pause and the tape will be fast-forwarded until the end of that side.
- After the tape has been advanced for 10 seconds at the beginning of side B, recording of side B will begin.

Recording operation (CCRS)

CCRS function description

The CCRS (Computer-Controlled CD Recording System) makes the following convenient recordings possible by setting the optimum tape recording level for the specific CD to be recorded and starting recording automatically.

Preparations

→ P20

- ① Insert a cassette tape.
- ② Select reverse mode (either to record both sides once or to record one side only).
- ③ Select DOLBY NR if desired.
- ④ Select the direction of tape movement: A (forward) or B (reverse).
- ⑤ Insert the CD to be recorded.

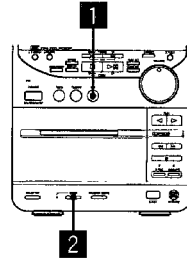

CCRS recording

1 Select the CD input.

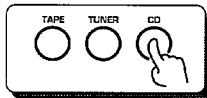

To program desired tracks, set the unit to program mode.

→ P18

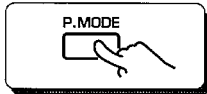

To edit desired tracks, set the unit to edit mode.

→ P24

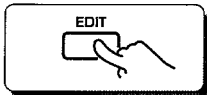

- After selecting the CD input, press "□" in the CD section to stop the operation.

CCRS EDIT recording

If the actual length of the tape is longer than the recording time entered in EDIT mode:

After recording of the tunes for side A is completed, the tape is forwarded to the end of side A and recording starts again at the beginning of side B.

If the actual length of the tape is shorter than the recording time entered in EDIT mode:

The tracks still remaining at the end of side A are left unrecorded, and recording at the beginning of side B starts with the first track edited for side B.

2 Press the CCRS key

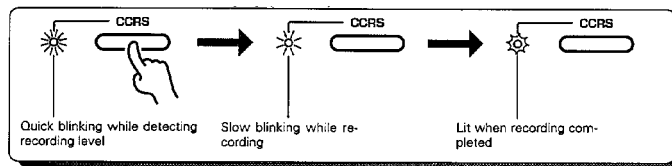

When the [CCRS] key is pressed, the CD is played and the optimum recording level is selected automatically. After the recording level is set, recording automatically starts. When recording reaches the end of side A of the tape, the tape automatically reverses and continues recording on side B.

- CCRS setting is canceled by pressing the lid "▲" button of the CD player.
- During CCRS operation, keys other than "□" on the CD player, "DISPLAY", and "■" on the cassette deck do not function.

Track mode

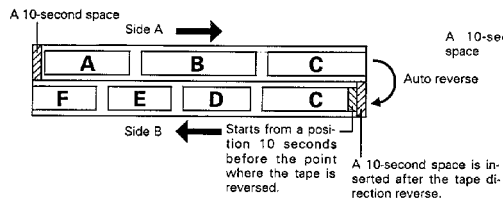

Program mode

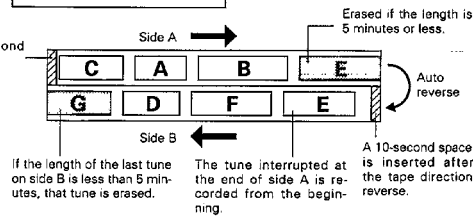

Changing the tone

- Neither "ACOUSTIC" nor "N.B. CIRCUIT" key functions during EDIT recording.

■ ACOUSTIC key (ASLC...Acoustic Sound Level Control)

The ACOUSTIC control circuit can be changed to alter the character of the sound. With ACOUSTIC set to ON, the sound field will be broadened to give the feeling of being surrounded by sound.

■ NB CIRCUIT key

When listening at a low volume, the human ear has difficulty hearing both low and high sounds. The circuit used to correct this is called a loudness control circuit. This unit is equipped with a LOUD function for loudness control and an EX BASS function that gives rich bass sound.

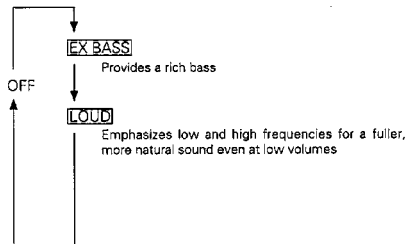

Toggles between these in the order shown above each time the key is pressed.

- By combining the ACOUSTIC circuit and the NB CIRCUIT functions, you can experience a variety of sound variations.

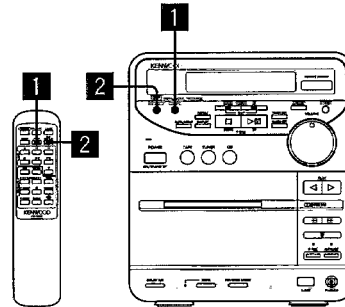

Changing the image control

1 Setting ACOUSTIC.



For the remote control unit, press the ASLC key.

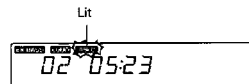

Changing the NB circuit

2 Setting NB CIRCUIT.



The set mode is lit

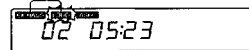

Operation of timer

Timers other than the sleep timer will not function if the present time is not set.

The timer of the system can be used for the following functions.

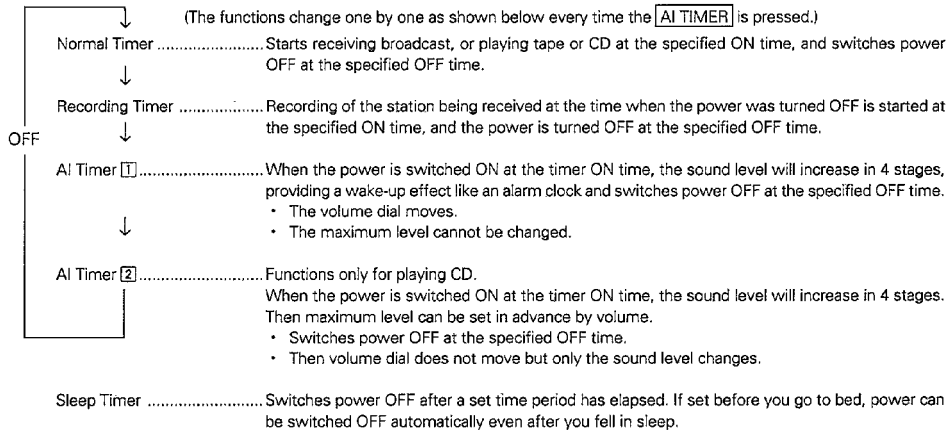

Set the ON and OFF times (main unit only)

1 Set the ON time.

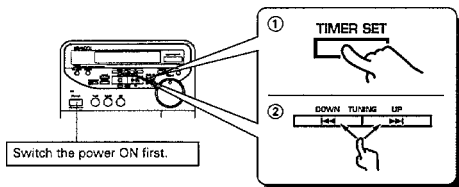

- The ON time is displayed.



- To increase the minute setting, press the UP key once. The minute setting will increase 1 minute each time the key is pressed. Holding the key down will cause the minute and hour settings to increase quickly.
- To decrease the minute setting, press the DOWN key once. The setting will decrease 1 minute each time the key is pressed. Holding the key down will cause the minute and hour settings to decrease quickly.

2 Set the OFF time.

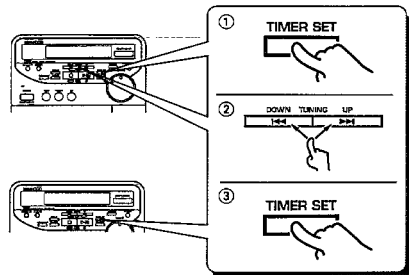

- The OFF time is displayed.

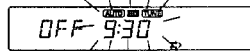

- Adjust the setting in the same manner as for the ON time.
- The OFF time is displayed for approx. 2 seconds and then the original display returns.



Checking the time setting

- Press the "TIMER SET" key.
- The display changes every time the [TIMER SET] key is pressed as shown right.



Operation of timer

Preparations

→ P28

- ① Turn the power on.
- ② Set the ON and OFF times.

- **TIMER RECORDING:** the last station to be tuned in is recorded

To start playback using the timer

1 Set the input source.

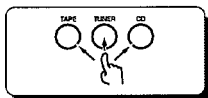

Stop playing a CD or a tape.

2 Select the TIMER mode.

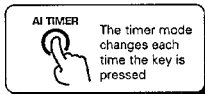
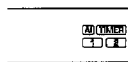

3 When AI TIMER 2 is set, adjust the volume dial.

- In the AI TIMER 2 mode, the CD playback is selected.

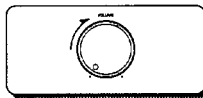

4 Turn off the power.

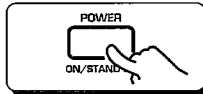

The power will automatically go on when the set time is reached.

To Start Recording Using the Timer

1 Tune in the desired station.

→ P14

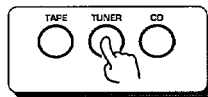

2 Insert the tape on which the broadcast is to be recorded.

→ P20

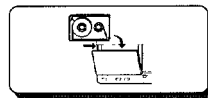

3 Set the desired timer recording mode.

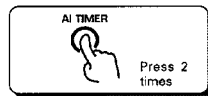
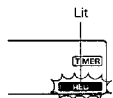

4 Turn off the power.

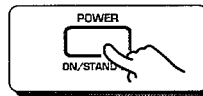

- The power will go on automatically and recording will begin when the set time is reached.

Using the SLEEP Timer (Remote Control Unit Only)

Setting the SLEEP time



→ 90 → 80 → 70 0

The remaining time decreases every time the SLEEP key is pressed.

- The time will be reduced in 10-minute increments each time the key is pressed.
- If the key is not pressed within 10 seconds, the previous display will reappear.
- When the set amount of time has elapsed, the power will go off automatically.
- When the SLEEP timer is on, the power will not go off even if another timer OFF time is reached.
- **To cancel SLEEP timer mode**
 - ① Either press the SLEEP key until the remaining time display shows "0"; or
 - ② Press the POWER key to turn off the power.

Using the DISPLAY key

Normal Display

- Normally the display section shows the source currently playing

Example: When a CD is playing

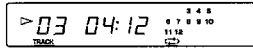

When a tape is playing

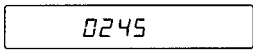

When receiving a radio broadcast



When DISPLAY key is pressed

- Toggles between the modes shown below

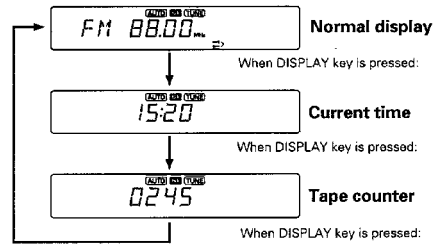

Resetting the Tape Counter

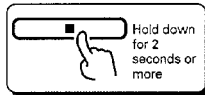

- When the "■" key on the deck is held down for 2 seconds or more while the tape is stopped, the tape counter will be reset to "0000".

In case of difficulty

What appears to be a malfunction may not always be serious. If your unit should not perform as expected, consult the table below to see if the program can be corrected.

Amplifier, speakers section

Symptom	Cause	Remedy
Sound is not output.	<ul style="list-style-type: none"> The speaker cords are disconnected. The volume dial is set to the minimum position. The headphone plug is left inserted in the [PHONES] jack. 	<ul style="list-style-type: none"> Connect them properly. (Refer to page 9.) Adjust the volume to a proper level. Remove the plug.

Tuner section

Radio stations cannot be received.	<ul style="list-style-type: none"> No antenna is connected. The frequency of the desired station is not tuned. 	<ul style="list-style-type: none"> Connect an antenna properly. (Refer to page 8.) Tune the unit to the desired frequency correctly.
------------------------------------	--	--

Cassette decks section

Sounds is not produced when the Play key is pressed.	<ul style="list-style-type: none"> The head is dirty. Tape is irregularly wound and hard to take up. A non-recorded tape is being played. 	<ul style="list-style-type: none"> Clean the head. (Refer to page 6.) Replace the tape. Play a recorded tape.
DPSS malfunctions.	<ul style="list-style-type: none"> The tape is not suitable for DPSS operation, for example the spaces between tunes are too short. 	<ul style="list-style-type: none"> Read page 21.
Sound is hoarse, or high frequencies are not audible.	<ul style="list-style-type: none"> The head is dirty. The tape is stretched or wrinkled. 	<ul style="list-style-type: none"> Clean the head. (Refer to page 6.) Replace the tape.
Recording is not initiated when the Recording key is pressed.	<ul style="list-style-type: none"> The protection tab on the cassette has been broken. The cassette holder is not closed completely. The TAPE input selector has been selected on the amplifier. Tape has been fully wound to a reel. 	<ul style="list-style-type: none"> Close the hole. (Refer to page 6.) Close the cassette holder completely. Press the input select key of the source to be recorded. Change the tape transport direction of Deck or insert the tape inversely.
Noise level is high.	<ul style="list-style-type: none"> The head is magnetized. 	<ul style="list-style-type: none"> Demagnetize the head. (Refer to page 6.)
Sound is vibrating.	<ul style="list-style-type: none"> The capstans or pinch rollers are dirty. Tape is irregularly wound. 	<ul style="list-style-type: none"> Clean the head. (Refer to page 6.) Wind the tape regularly by fast forwarding and rewinding.

CD player section

Disc has been placed but it cannot be played.	<ul style="list-style-type: none"> The center of the disc is not aligned with the turning center correctly. The disc is placed upside down. The disc is very dirty. The disc is scratched or damaged. Dew is condensed on the optics lenses. 	<ul style="list-style-type: none"> Set the disc properly as shown in the figure on page 16. Place the disc properly, with the labeled side up. Clean the disc then play it again. (Refer to page 6.) Replace the disc. Read page 7.
Sound skips.	<ul style="list-style-type: none"> The disc is dirty. The disc is scratched or damaged. Vibrations are applied to the CD player. 	<ul style="list-style-type: none"> Clean the disc then play it again. (Refer to page 6.) Replace the disc. Install the system in a place which is not subject to vibrations.

Notes:

- With some tapes, a squeaky noise is produced when the tape is stopped automatically. This is due to the tape protection function, and not a malfunction.
- Do not use 110-, 120- nor 150-minute tapes, for these tapes are too thin and get easily tangled.
- As this unit employs microprocessor, the unit sometimes malfunctions due to external high-level interference. At that time, press the POWER key to turn the power off. Disconnect the power cord. Then, while pressing the AUTO/MONO key and A-PRESET key, connect the power cord to reset the unit.
(When the unit is reset, the memorized settings are erased.)

Specifications



Center unit

Amplifier section

Rated power output

For U.S.A. and Canada

10 watts per channel minimum RMS, both Channels driven, at 6 Ω from 60 Hz to 20,000 Hz with no more than 5% total harmonic distortion (FTC)

For U.K. and Europe

(DIN) 1 kHz at 6 Ω 10 W + 10 W

(IEC) 1 kHz at 6 Ω 10 W + 10 W

For other countries

(EIAJ) 1 kHz at 6 Ω 12 W + 12 W

Total harmonic distortion (1 kHz, 3.3 W, 6 Ω) 0.1%

Frequency response 60 Hz to 20 kHz

Tuner section

FM Tuning frequency range 88 MHz to 108.0 MHz

AM Tuning frequency range See below.

CD player section

Laser Semiconductor laser

Frequency response 60 Hz to 20 kHz

Signal to noise ratio higher than 80 dB

Wow & flutter under the measurable limit

Cassette deck section

Type 4 track 2 channel

Recording system AC bias (Frequency: 105 kHz)

Heads Playback/recording head 1

Erasing head 1

AM tuning frequency range

U.S.A.	530 kHz to 1710 kHz
CANADA	530 kHz to 1710 kHz
AUSTRALIA	531 kHz to 1602 kHz
EUROPE	531 kHz to 1602 kHz
U.K.	531 kHz to 1602 kHz
OTHER COUNTRIES	530 kHz to 1610 kHz (10 kHz STEP Area) 531 kHz to 1602 kHz (9 kHz STEP Area)

Frequency response

Normal 50 Hz to 14 kHz

CrO₂ tape 50 Hz to 15 kHz

Signal to noise ratio (DOLBY NR ON) 56 dB

Wow & flutter 0.15% (W.R.M.S)

General

Power consumption 35 W

Dimensions 175(W) × 204(H) × 225(D) mm

Weight 3.3 kg

Speakers

Type 2-Way system, bass-reflex type

Rated impedance 6 Ω

Maximum input level 15 W

Output sound pressure 88 dB/W/m

Frequency response 80 Hz to 20 kHz

Dimensions 126(W) × 204(H) × 195(D) mm

Weight 1.6 kg

KENWOOD follows a policy of continuous advancements in development. For this reason specifications may be changed without notice.

For the U.S.A.

FCC WARNING

This equipment may generate or use radio frequency energy. Changes or modifications to this equipment may cause harmful interference unless the modifications are expressly approved in the instruction manual. The user could lose the authority to operate this equipment if an unauthorized change or modification is made.

NOTE:

This equipment has been tested and found to comply with the limits for a Class B digital device, pursuant to Part 15 of the FCC Rules. These limits are designed to provide reasonable protection against harmful interference in a residential installation. This equipment may cause harmful interference to radio communications, if it is not installed and used in accordance with the instructions. However, there is no guarantee that interference will not occur in a particular installation. If this equipment does cause harmful interference to radio or television reception, which can be determined by turning the equipment off and on, the user is encouraged to try to correct the interference by one or more of the following measures.

- Reorient or relocate the receiving antenna.
- Increase the separation between the equipment and receiver.
- Connect the equipment into an outlet on a circuit different from that to which the receiver is connected.
- Consult the dealer or an experienced radio/TV technician for help.